

SPEAKMAN®

SEF-1823

EYESAVER® FAUCET SPECIFICATIONS

DESCRIPTION

The SEF-1823 Eyesaver® faucet combines a sensor activated gooseneck faucet with an independently operated eyewash. The faucet features a 8" deck plate with thermostatic mixer while the eyewash offers twin aerated sprays and flip-top dust covers.

SPECIFICATIONS

EYEWASH

Activator: Pull handle with graphics
Spray heads: (2) aerated yellow plastic spray outlets with flip-top dust caps
Performance: 2.6 gpm @ 30 psi
Approvals: Meets ANSI Z358.1

FAUCET

Supply: 3/8" compression connections with male threads for hot and cold inlets
Center Distance: 4"
Activator: Sensor AC powered
Performance: 2.2 gpm
Counter thickness: Up to 1 1/4" thick
Approvals: Meets ASME A112.18.1, CSA B125-98
Universal Emergency Sign Included

OPTIONS

- BO Vandal resistant 0.5 gpm flow control
- HS Two (2) Stainless steel flexible supply hoses to supply stops
- LF Laminar flow outlet 2.2 gpm
- NA No aerated eyewash
- ST Serrated tip with vacuum breaker
- TW Addition of SE-370 thermostatic mixing valve
- 8 8" gooseneck spout

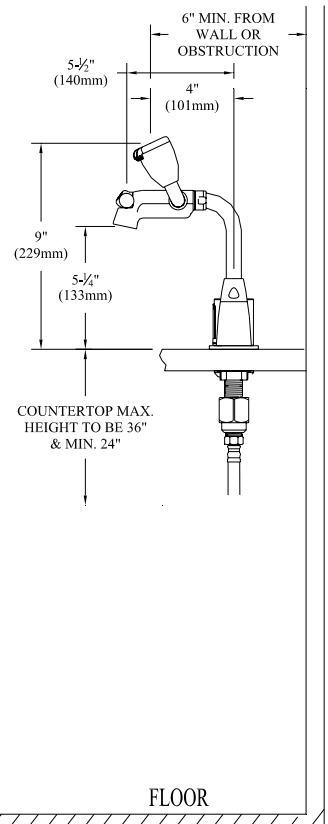
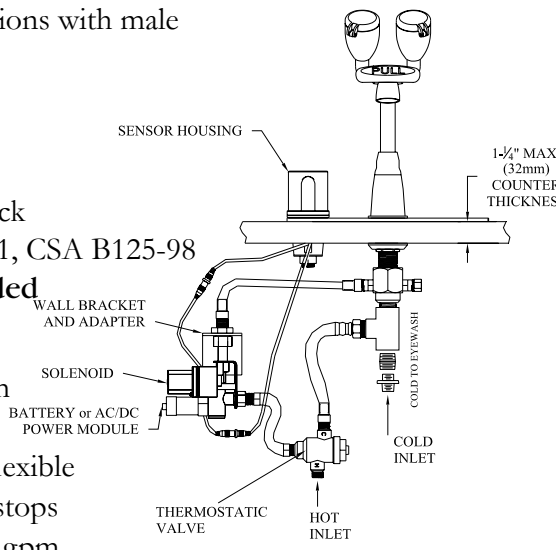

Job Name _____	
Location _____	
Architect/Engineer _____	
Sales Representative _____	
Wholesaler _____	
Date _____	Model # _____