

Instructions for Models:

SA-1203

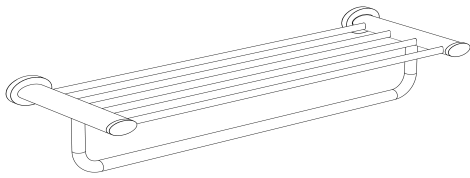

Need Help?

For additional assistance or service call:

SPEAKMAN Company
400 Anchor Mill Road
New Castle, DE 19720

PHONE: 800-537-2107
EMAIL: customerservice@speakmancompany.com
WEB: www.speakmancompany.com

92-3433-R1

What You Need To Know:

Tools:

Required:

Phillips
Screwdriver

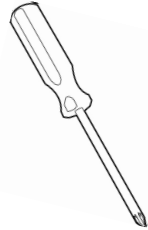

Drill w/
7/32" drill bit

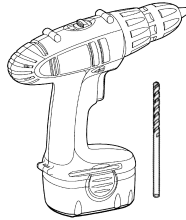

Level



Pencil

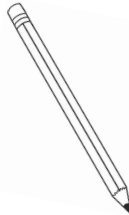

Important Notes:

Be sure to read instructions thoroughly before beginning installation. Do not overtighten any connections or damage may occur.

Safety Tips:

Cover your drain to prevent loss of parts.

Maintenance:

Keep the Towel Shelf looking new by cleaning it periodically with a soft cloth. Avoid abrasive cleaners, steel wool, and harsh chemicals as these will dull the finish and void your warranty.

1 Loosen Set Screw at base of each end of Towel Shelf and remove Mounting Brackets.

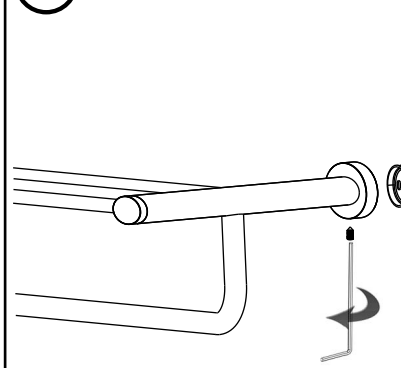

2 Determine mounting location of Towel Shelf and lightly trace outline with Pencil. Use Level to ensure Towel Shelf is parallel to ground.

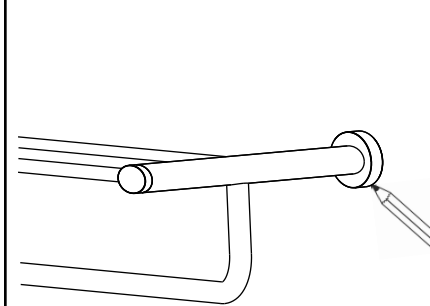

3 Center Mounting Bracket within traced outline. Mark the (2) two mounting locations with a pencil.

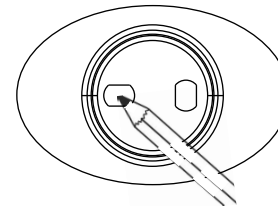

4 Drill 7/32" holes in marked locations. If mounting directly into stud or wood wall, secure Mounting Brackets to wall using Mounting Screws without drilling holes.

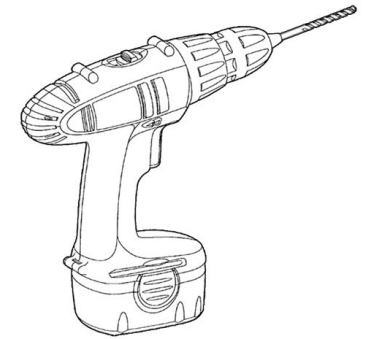

5 Insert Plastic Anchors into drilled holes and press in until flush with wall. Secure Mounting Brackets to wall with Mounting Screws using Phillips Screwdriver.

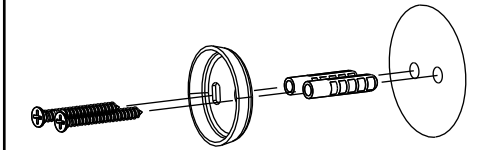

6 Locate of Towel Shelf over Mounting Bracket and tighten Set Screw with provided Allen Wrench (both sides).

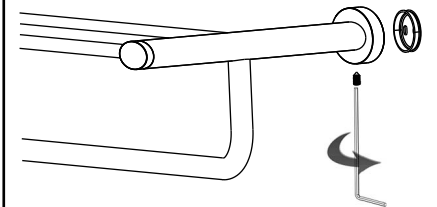

EXPLODED VIEW

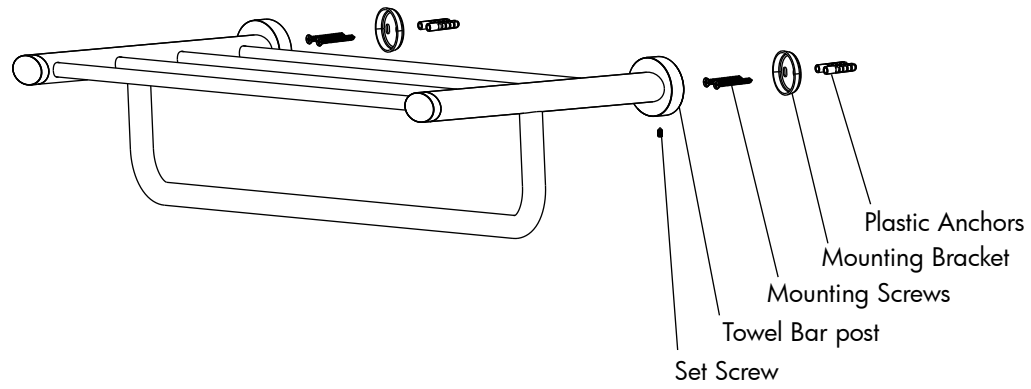

ROUGH-IN

