

## **SPEAKMAN COMPANY**

### **S-9100, S-9200, S-9300, S-9400, S-9700, S-9800 Series**

#### **Installation, Maintenance & Operation Instructions**

#### **SENSORFLO® BATTERY or AC POWERED SLIM DESIGN FAUCETS with DIFFERENT OPTIONS**

The Designer Series Faucet is an addition to the existing family of Speakman Sensorflo Products. Its unique features such as operating mechanisms ( Solenoid and Power pack) ready serviceable from under the counter, integral Hot and Cold mechanical mixing valves, Hot and Cold water supply check valves, standard inline filters, and a new Sensor Module design incorporated into solid brass Faucet body make it ideal for public areas such as schools, hotels, laboratories, and hospitals.

Speakman SENSORFLO® Slim Design Faucets, Batteries or AC/DC powered comes in different Faucet Spout shapes as: Gooseneck, Modern Tubular or Cast C-Spout, all with a Sensor Module installed inside.

Inside the solid brass body of the Faucet sits only the Infrared Sensor Module. The Solenoid and the Power Supply (Batteries or AC/DC adaptor) are located under the sink with easy accessibility.

The Sensor module is powered by two (2) 3-volt DC lithium batteries or AC/DC adaptor with waterproof connectors housed in a separate Power Module attached under counter mounted onto the Solenoid body. There is a low battery warning light that pulsate before the batteries are depleted and keeps pulsating at least for 2 weeks after they are no longer in service.

Speakman SENSORFLO faucets are thoughtfully designed and engineered in accordance with the highest quality and performance standards. Require no handles to turn, lift or push water flows. Built in vandal resistant circuitry shuts off the water after continuous flow of approximately 60 seconds. This feature prevents flooding: -water is easily turned on again by placing one's hands under the lavatory spout.

Water conserving vandal resistant recessed aerator reduces water flow to 2.2 GPM / 8.4 LPM to meet requirements of ANSI A112.18.1M for flow rates. There is a water Filter on the Solenoid ready accessible for maintenance purposes. ADA (American Disabilities Act) compliant. NOTE: Stainless steel hoses are optional.

#### **SPECIFICATIONS**

INLET SUPPLY: 3/8" COMPRESSION WITH MALE THREADS for Cold and Hot Water  
 FLOW RATE: 2.2 GPM / 8.4 LPM  
 FINISH: BRASS CHROME PLATED

#### **OPTIONS**

BO – Boca VR 0.5 GPM Flow Control HS – 2SS Hoses for use with UCM, 3/8"compression  
 LF – Laminar Flow 2.2 GPM Flow Control HTS – 1SS Hose for Tempered water, 3/8"compression  
 TMV – UC Thermostatic Valve with check valves –T – Tee with checks  
 GB – Vandal resistant 1.5 GPM Aerator Outlet device

All Faucets come in different combinations with:

NO Deck Plate  
 4" Deck Plate  
 8" Deck Plate  
 UCM (under counter mixing valve with built-in backflow check valves)  
 TMV (thermostatic mixing valve for more consistent water temperature with check valves)  
 ACM (above counter mixer)  
 MO (manual override)

Three different shapes of Faucets, all made of solid polished chrome brass can be mounted onto a unique Central Base with the Infrared Sensor Module. The Solenoid is attached to the central shank and has installed on it the Power Module that can be either with batteries or AC adaptor that plugs into a Transformer.

**SPEAKMAN®**

PO Box 191 Wilmington, DE 19899 Phone: 800-537-2107 Fax: 800-977-2747  
 Visit us on the web at [www.speakmancompany.com](http://www.speakmancompany.com)

92-2840-R2

Different combinations could be made between UCM (or TMV), ACM and MO mounted directly onto Counter Top or onto 4" or 8" Deck Plates.

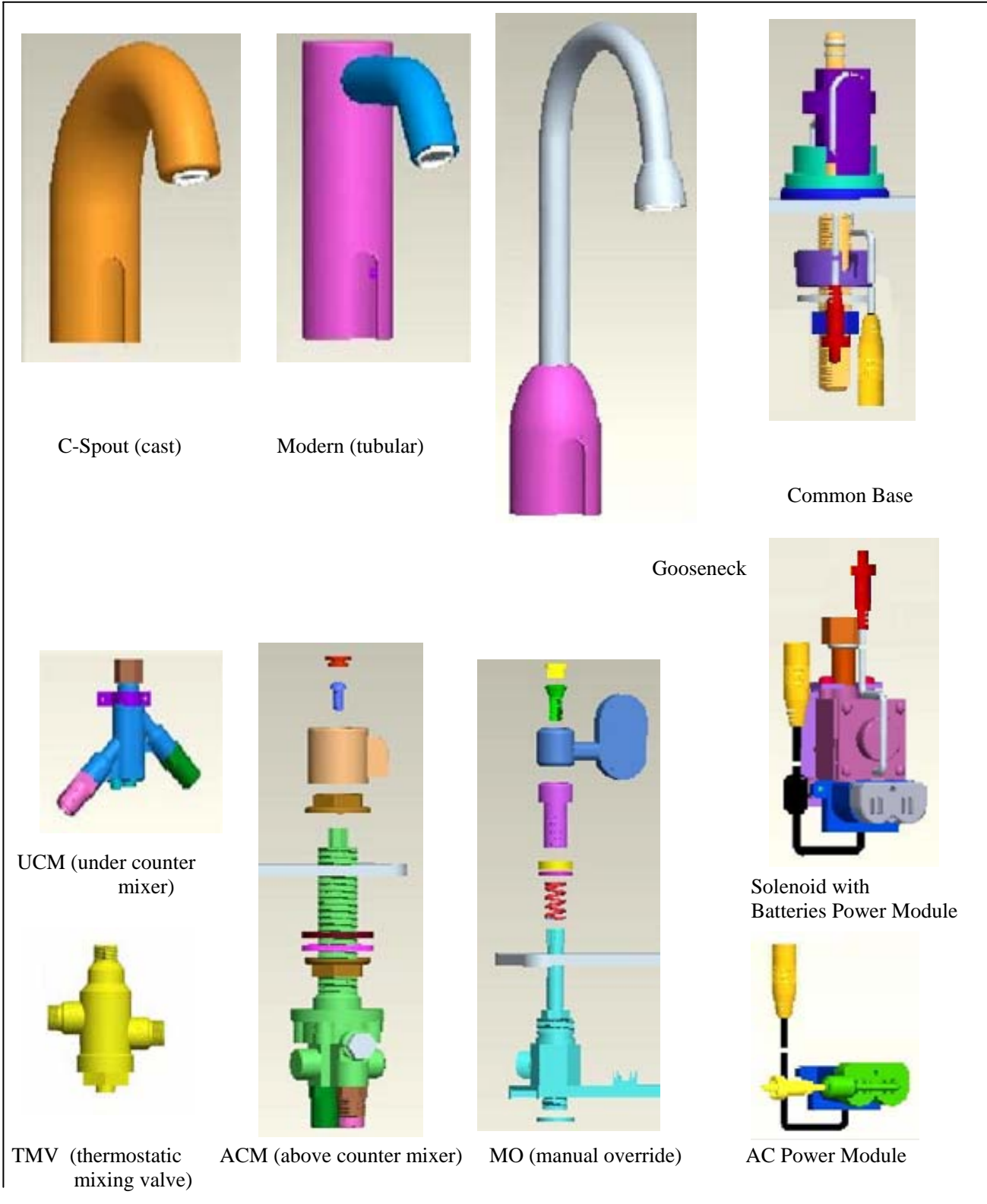

C-Spout (cast)

Modern (tubular)

Common Base

Gooseneck

UCM (under counter mixer)

Solenoid with Batteries Power Module

TMV (thermostatic mixing valve)

ACM (above counter mixer)

MO (manual override)

AC Power Module

**SPEAKMAN®**

PO Box 191 Wilmington, DE 19899

Phone: 800-537-2107 Fax: 800-977-2747

Visit us on the web at [www.speakmancompany.com](http://www.speakmancompany.com)

92-2840-R2

**INSTALLATION OF AERATOR**

To install vandal resistant aerator screw the aerator into the outlet of the faucet with the provided Speakman aerator wrench

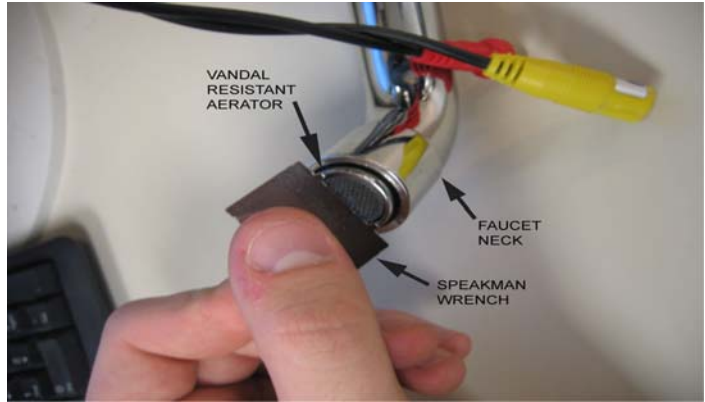

**INSTALLATION OF POWER MODULE TO SOLENOID**

If the Power Module (either battery or AC) is not installed onto Solenoid body, attached it as shown with 2 provided screws #8.



**INSTALLATION OF FAUCET**

Insert the faucet shank into a 1-1/8" hole with connector wires going in first, **taking care not to pinch the wires.**



If you have a Deck Plate (either 4" or 8"), first position the gasket and the Plate on the counter top and then insert the faucet shank through the hole.



**SPEAKMAN®**

PO Box 191 Wilmington, DE 19899

Phone: 800-537-2107 Fax: 800-977-2747

Visit us on the web at [www.speakmancompany.com](http://www.speakmancompany.com)

92-2840-R2

Under sink, place rubber wire guard (with notch facing forward) and pass the wires through notch. The wires should be inside channel of rubber wire guard to prevent pinching when tightening. Insert metal washer and tighten the locknut to provide enough tension into the rubber guard. While tightening make sure the position of Faucet on top of counter is straight. **Again make sure that the wires are not pinched.**

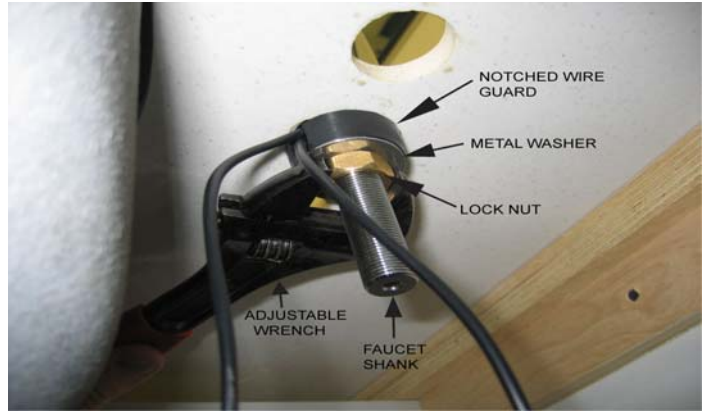

Install the solenoid by engaging the thread by hand first and continuing to tighten with an adjustable wrench (you will need to hold Faucet on top to prevent rotation). Do not overtighten and don't use any sealant. **DRY CONNECTION ONLY.**

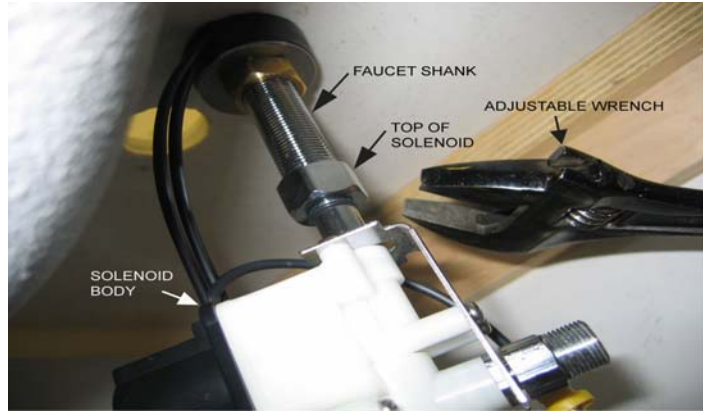

Connect the two faucet wires with the solenoid wires. The connectors are color coded. If you have an AC/DC unit, there is an additional wire with black connector coming from the top of power module that needs to be connected to the transformer provided. (not shown)

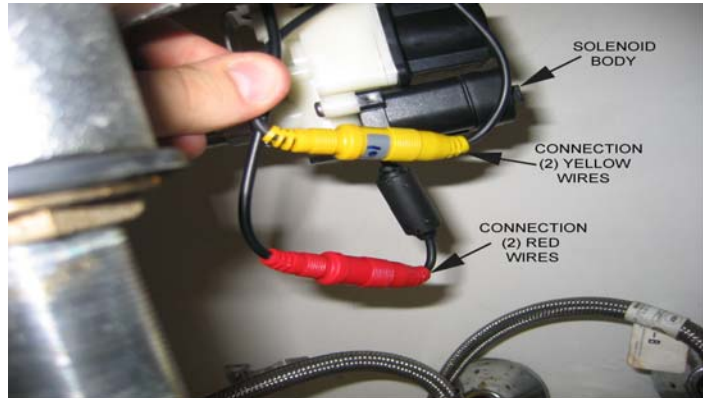

If the option has an UCM (under counter mixer), connect it to the inlet of the solenoid: -first by hand and then using an adjustable wrench (do not overtighten). **DRY CONNECTION ONLY.**

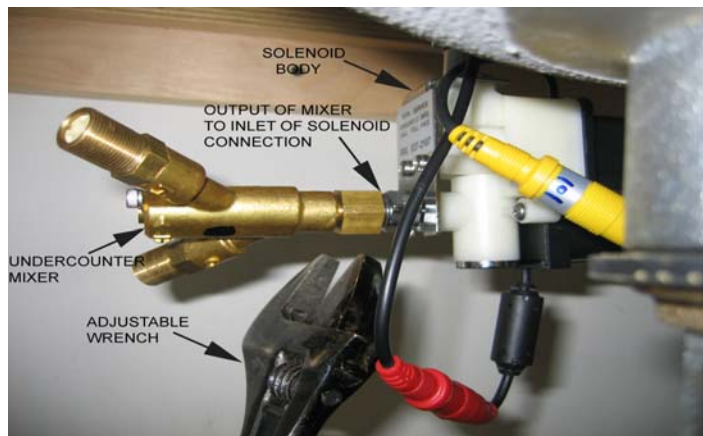

**SPEAKMAN**<sup>®</sup>

PO Box 191 Wilmington, DE 19899

Phone: 800-537-2107 Fax: 800-977-2747

Visit us on the web at [www.speakmancompany.com](http://www.speakmancompany.com)

92-2840-R2

Install 3/8" compression fitting hoses to the UCM (under counter mixing valve). The hot and cold sides are marked H and C. Hand tighten connections and then slightly tighten with an adjustable wrench.

**DRY CONNECTION ONLY.**

**NOTE:** During winter month it may be necessary to reverse Hot and Cold connections to obtain warmer temperature range of water.

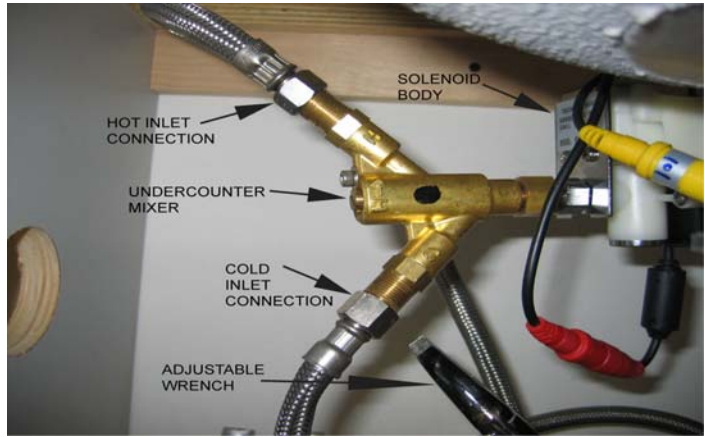

After connecting to supply lines, turn on the water and activate the faucet with your hands, checking for leaks. Adjust water temperature by rotating the screw on the UCM to your required temperature.

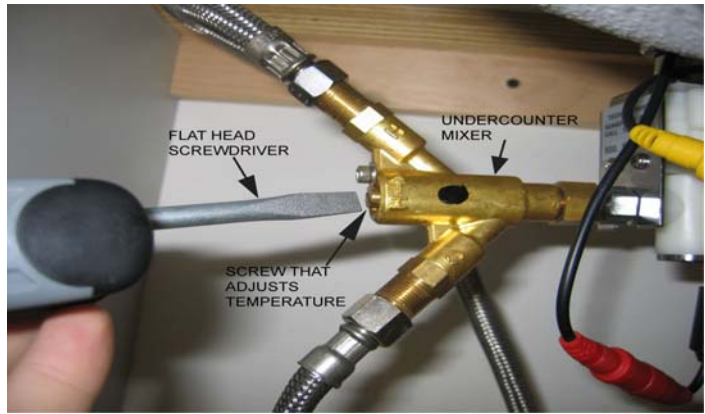

**REPLACEMENT OF SENSOR MODULE**

If the Faucet is mounted onto Deck, first take it out with proper care to not damage the connectors and the wires. Take out the Gasket from under Base of Faucet. Take the screw completely out of the back of faucet.

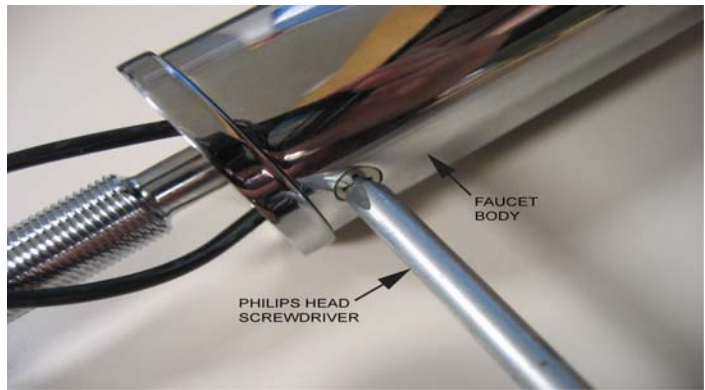

After screw has been removed from the unit, pull up faucet body top. There are 2 O-Rings on the shank and one around the lenses of Sensor Module that should be replaced if damaged.



**SPEAKMAN®**

PO Box 191 Wilmington, DE 19899

Phone: 800-537-2107 Fax: 800-977-2747

Visit us on the web at [www.speakmancompany.com](http://www.speakmancompany.com)

92-2840-R2

Remove the 2 screws on the clamp. After removing, pull up the Sensor Module from the central shank (do not damage the O-Rings and the wire connectors).

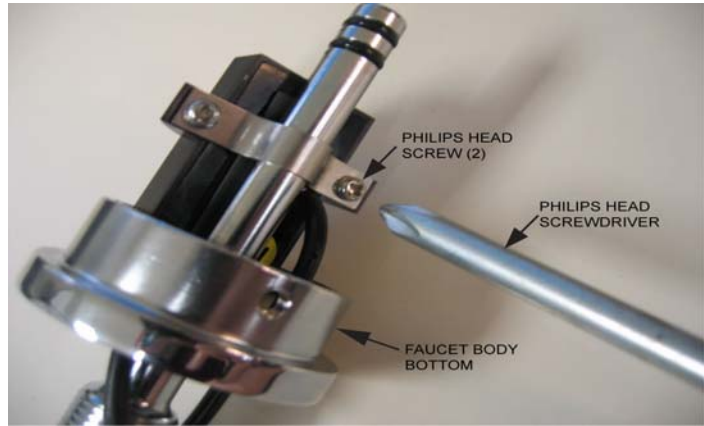

Reassemble new Module with care not to cut wires through the big holes into the Base, then insert the clamp with the Sensor over the shank. Tighten the 2 screws on clamp, making sure that the sensor sits on the flat of shank and touches the bottom of base. Grease the 2 O-Rings or change them if they are damaged. Take care when inserting Faucet Spout over the Sensor O-Ring and tighten the screw that was removed in the back.



### REPLACEMENT OF BATTERIES

To replace the batteries (if the unit purchased is a battery powered unit) first start by unscrewing the screw that is on the power module.

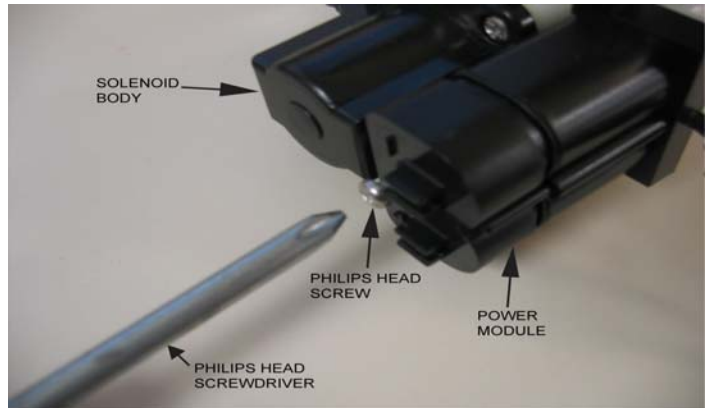

With the cover of the power module removed, remove the dead batteries and replace them with new batteries (ensure that the position of the new batteries matches the marks + and - on the cover). Replace the cover on Power Module.

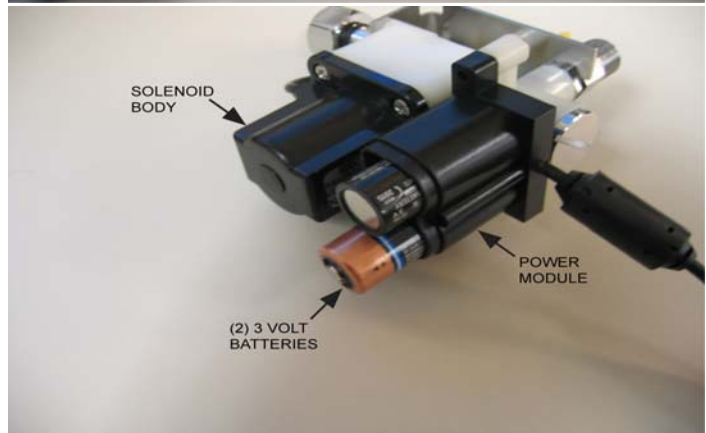

**SPEAKMAN**<sup>®</sup>

PO Box 191 Wilmington, DE 19899

Phone: 800-537-2107 Fax: 800-977-2747

Visit us on the web at [www.speakmancompany.com](http://www.speakmancompany.com)

92-2840-R2

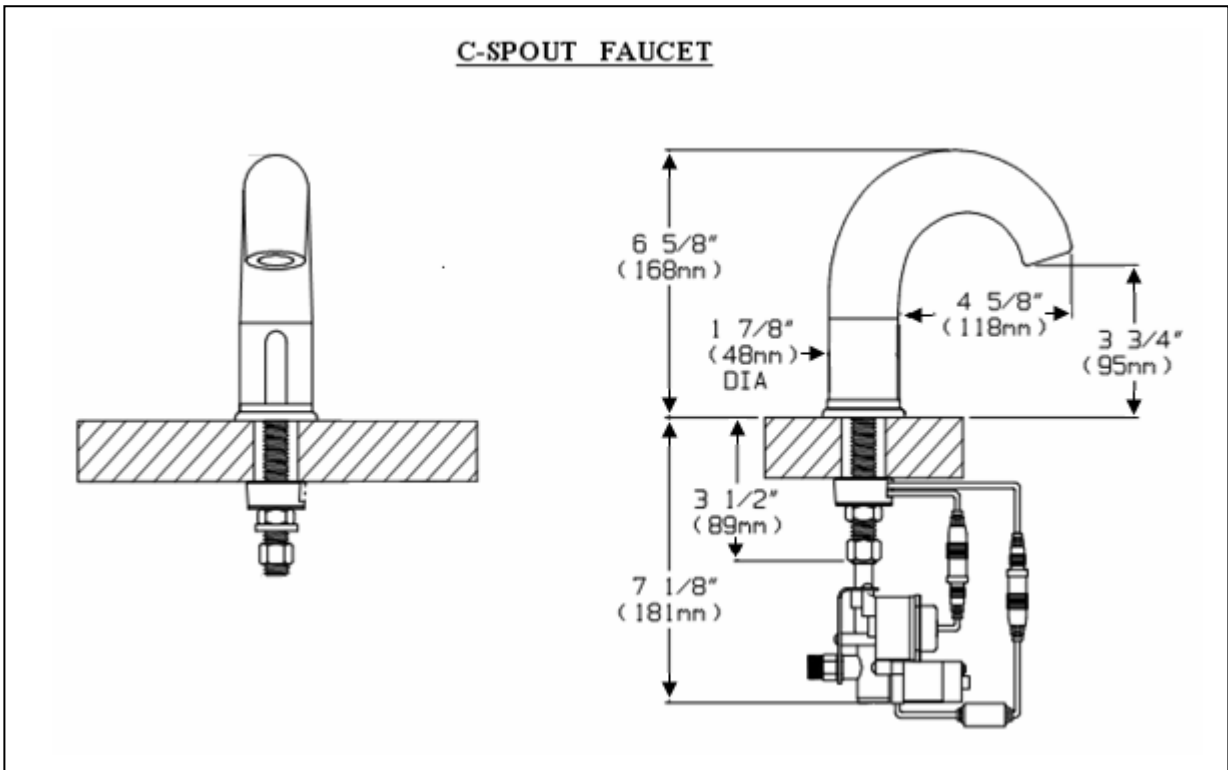
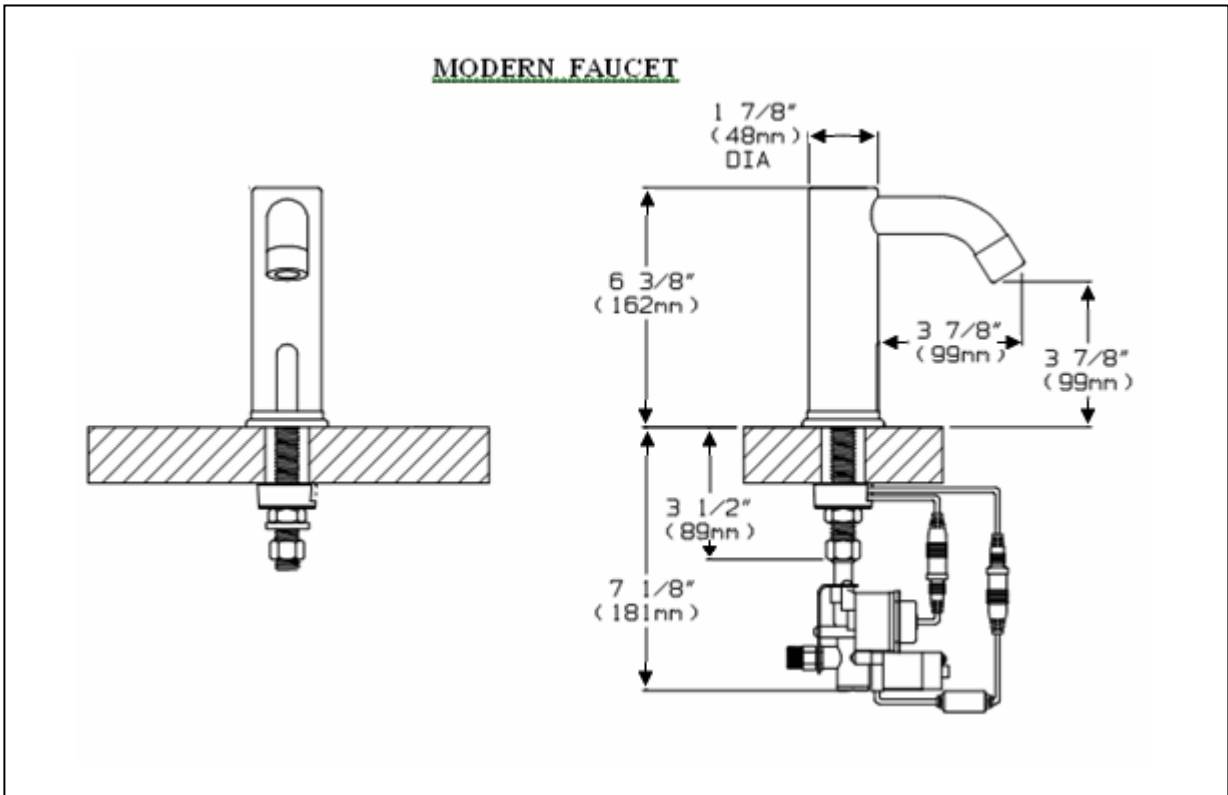

**SPEAKMAN®**

PO Box 191 Wilmington, DE 19899 Phone: 800-537-2107 Fax: 800-977-2747  
Visit us on the web at [www.speakmancompany.com](http://www.speakmancompany.com)

92-2840-R2

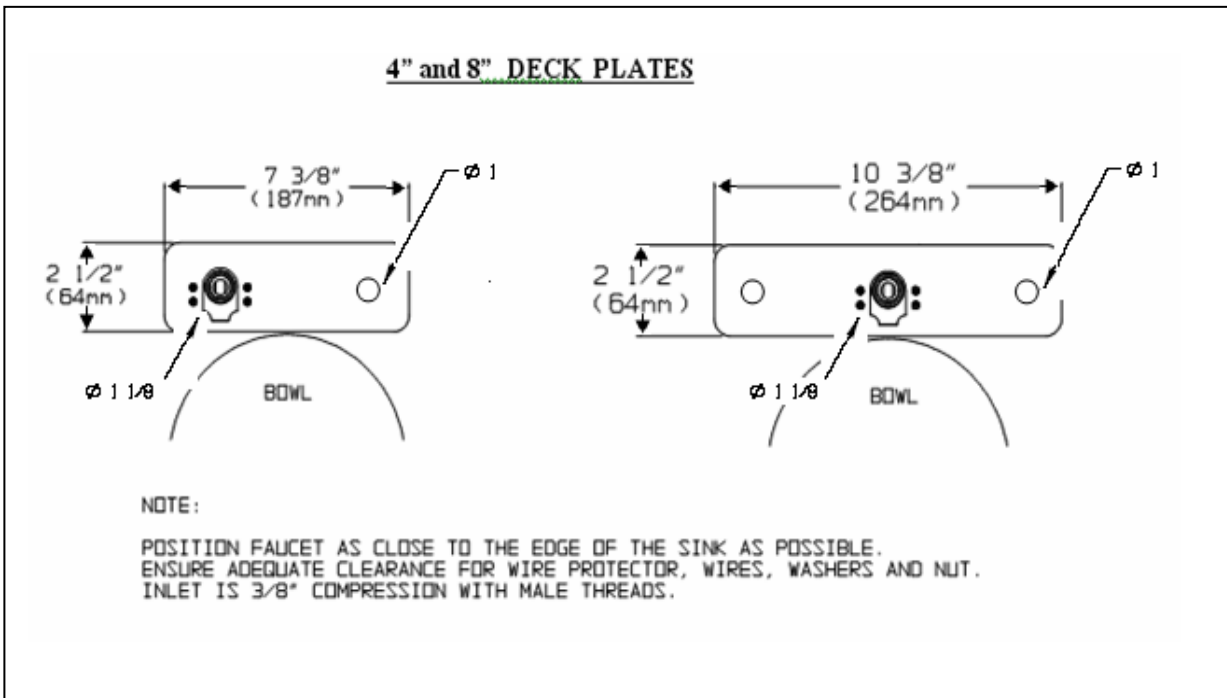
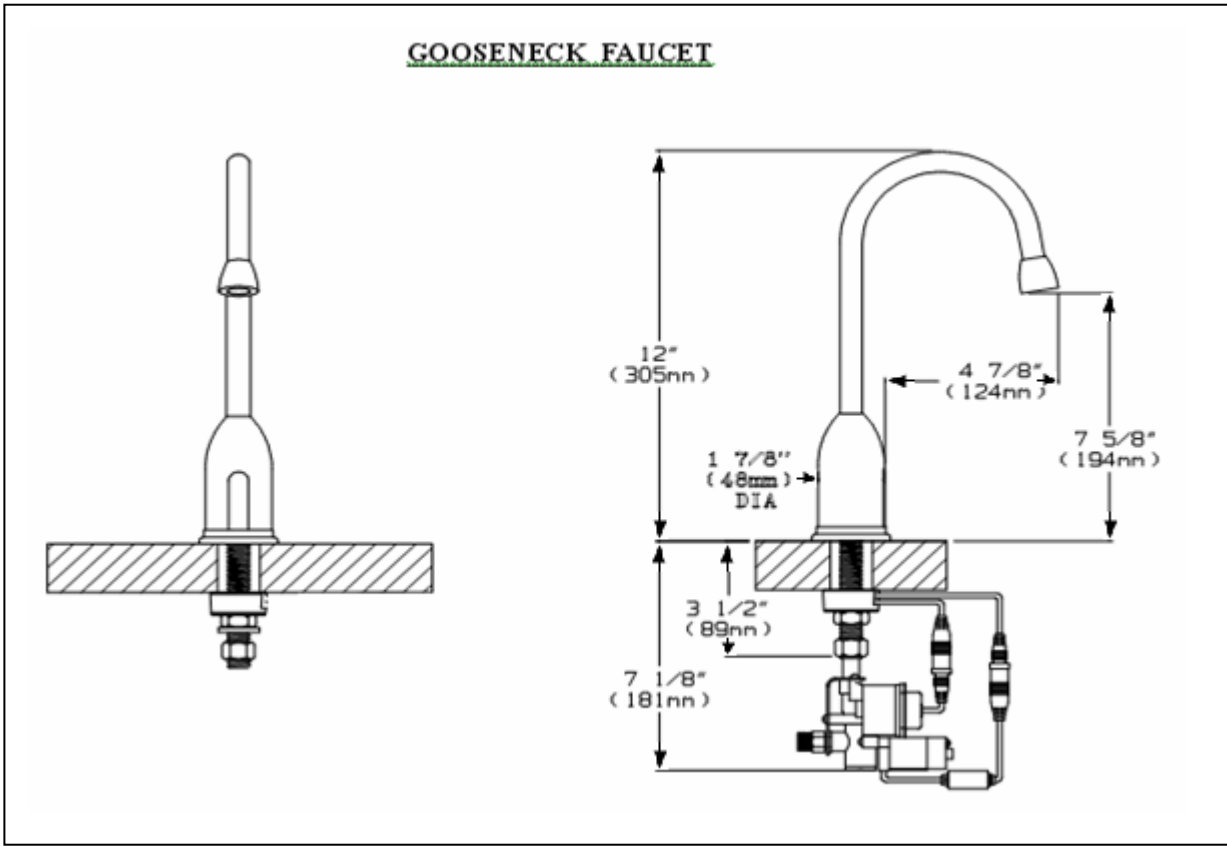



**3 BASIC MODELS:**

Three different shapes of Faucets, all made of solid polished chrome brass could be mounted onto a unique Central Base with the Infrared Sensor Module in it.

The Solenoid is attached to the central shank and has installed on it the Power Module that can be either with batteries or AC adapter that plugs into a Transformer.

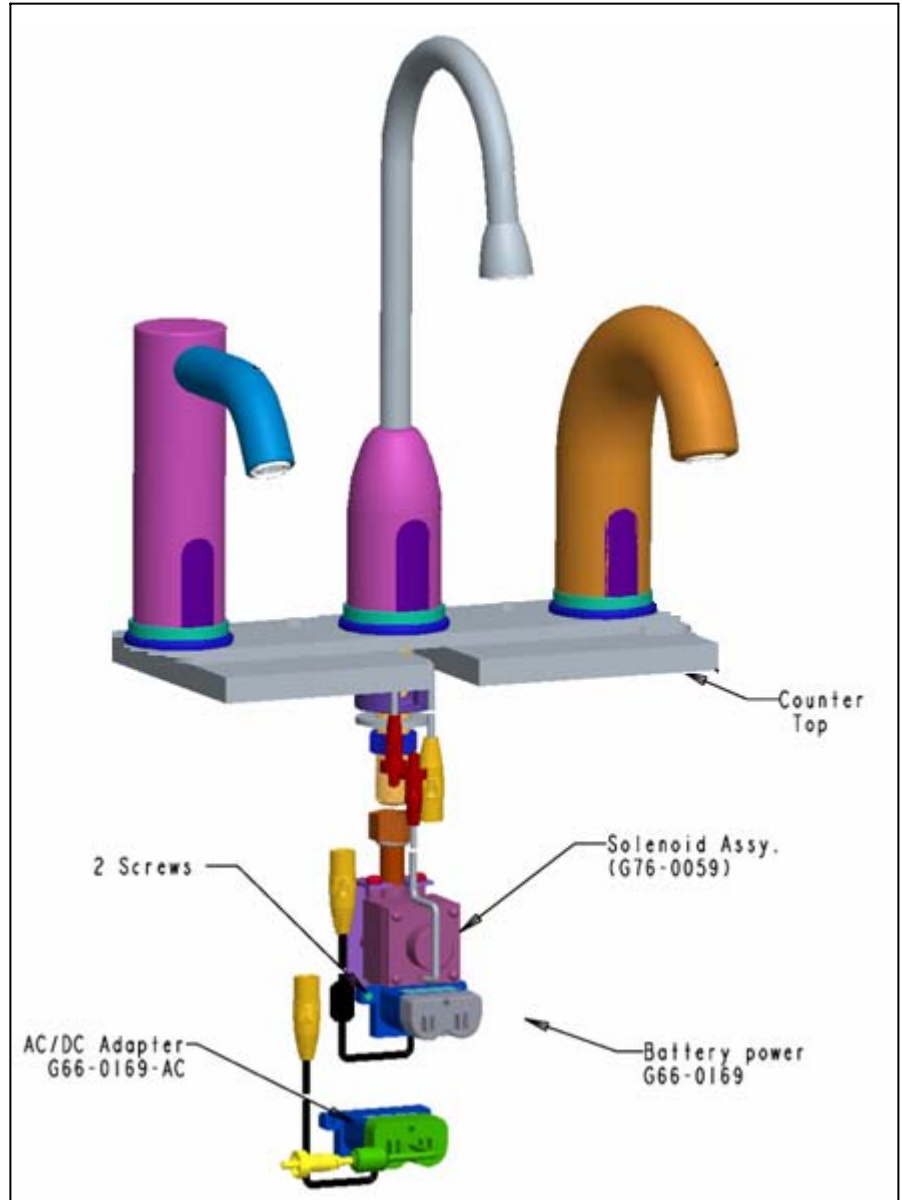

**SPEAKMAN®**

PO Box 191 Wilmington, DE 19899 Phone: 800-537-2107 Fax: 800-977-2747  
 Visit us on the web at [www.speakmancompany.com](http://www.speakmancompany.com)

92-2840-R2

**OPTIONS:****ACM (above counter mixer) Installation**

1. With the Flange Nut, steel washer and rubber washer on the shank, install ACM from the bottom.
2. Tighten the top Flange Nut adjusting the proper height above counter.
3. Tighten then the bottom Flange Nut until the assembly is fixed in place.
4. Insert the Handle and tighten with the screw onto the shank.
5. Snap the screw cover onto Handle.
6. Attach the Hot and Cold hoses from supply line to ACM (see marks on body)
7. The side connection out of ACM body goes to the Solenoid delivering mixed water.

**NOTE:** In this case the ACM has only outlet for mixed water supply to Solenoid

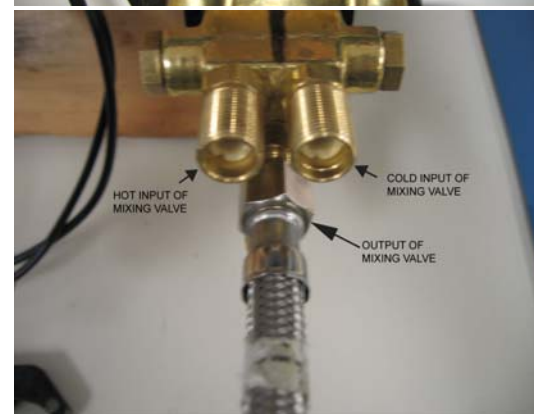
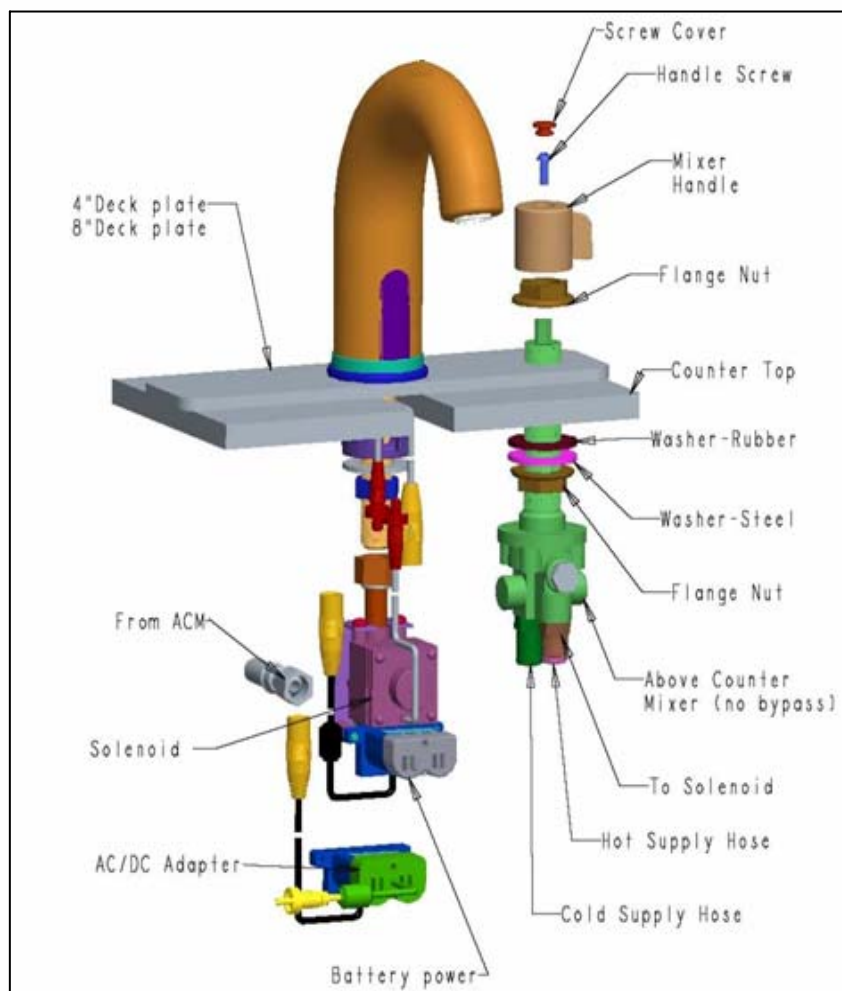

**SPEAKMAN®**

PO Box 191 Wilmington, DE 19899 Phone: 800-537-2107 Fax: 800-977-2747  
Visit us on the web at [www.speakmancompany.com](http://www.speakmancompany.com)

92-2840-R2

## MO (manual override) Installation

(Also see page 14)

1. First insert the Thin Nut on the Faucet shank a little higher.
  2. Insert Mount bracket and tighten the Solenoid Nut. (dry connection only)
  3. Lower the Thin Nut onto bracket
  4. Slip compression spring onto MO spindle
  5. With O-Ring attached to the Spacer, slip Spacer and Bearing Sleeve onto spindle
  6. With the lock washer and screw inside the Handle, properly position Handle onto Spindle.
  7. Push Handle down onto Spindle to compress the spring and tighten the screw.
  8. Snap Index Button into Handle
  9. The water supply splits into Tee, and one exit hose goes to Solenoid and the other hose goes to bottom of MO
  10. Form the side of MO the by-pass hose goes to the upper side of Solenoid discharge for manually controlled side
- NOTE:** For MO is used a Solenoid with a by-pass branch at its outlet. Use a Tee to split the supply water in 2 sides

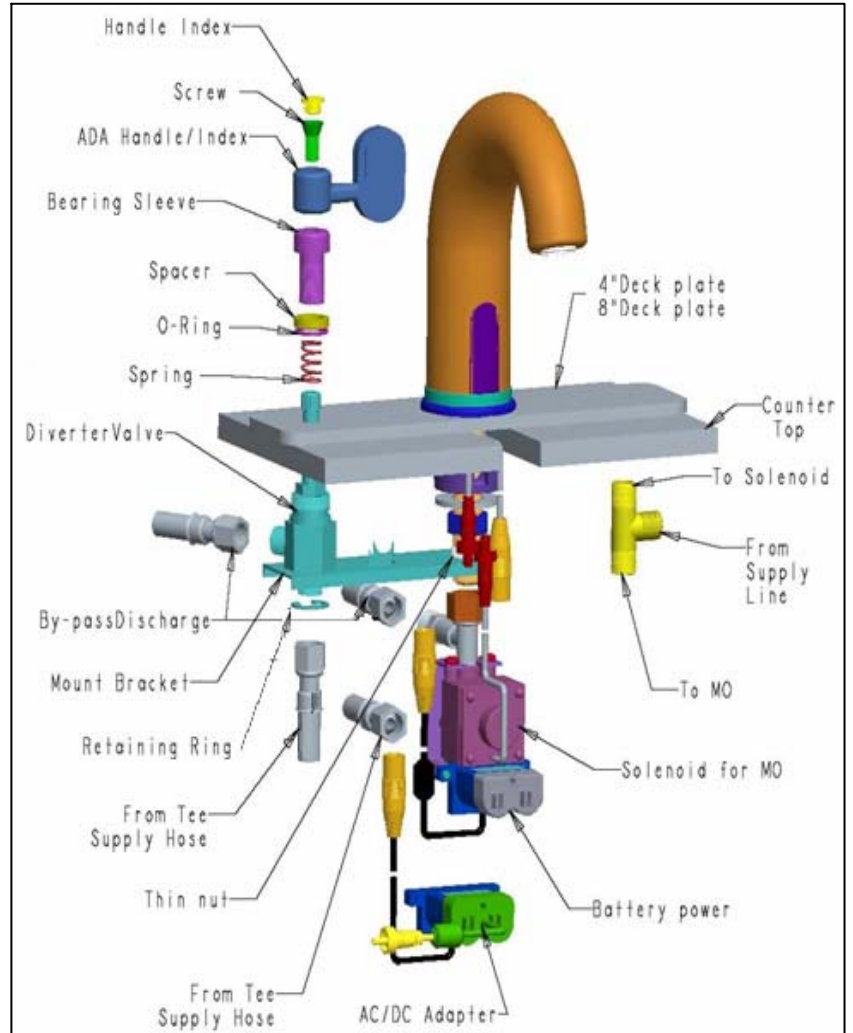
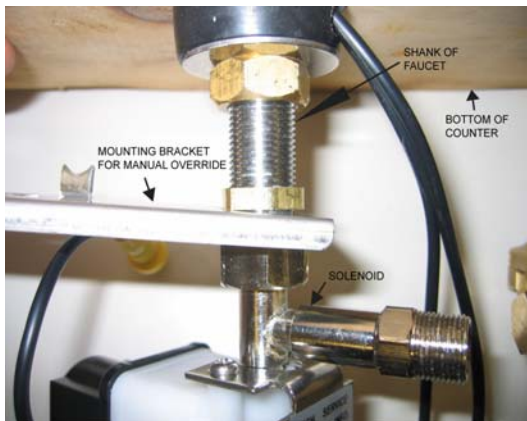
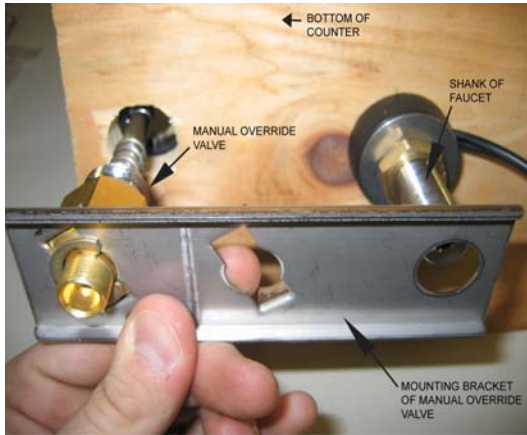

### UCM (under counter mixer) with MO (manual override) Installation

1. Install the MO as described above.
  2. Install the UCM fixed on the wall with the Clamp in the desired position.
  3. The UCM it is marked with H and C for hot and cold supply lines. The mixed water exits on top into the Tee.
  4. The water supply splits into the Tee: -one exit hose goes to Solenoid and the other hose goes to bottom of MO.
  5. Form the side of MO the by-pass hose goes to the upper side of Solenoid discharge for manually controlled side
- NOTE:** For MO is used a Solenoid with a by-pass branch at its outlet. Use a Tee to split the supply water in 2 sides

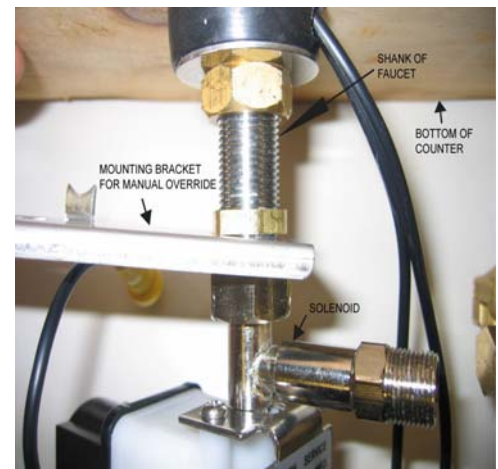
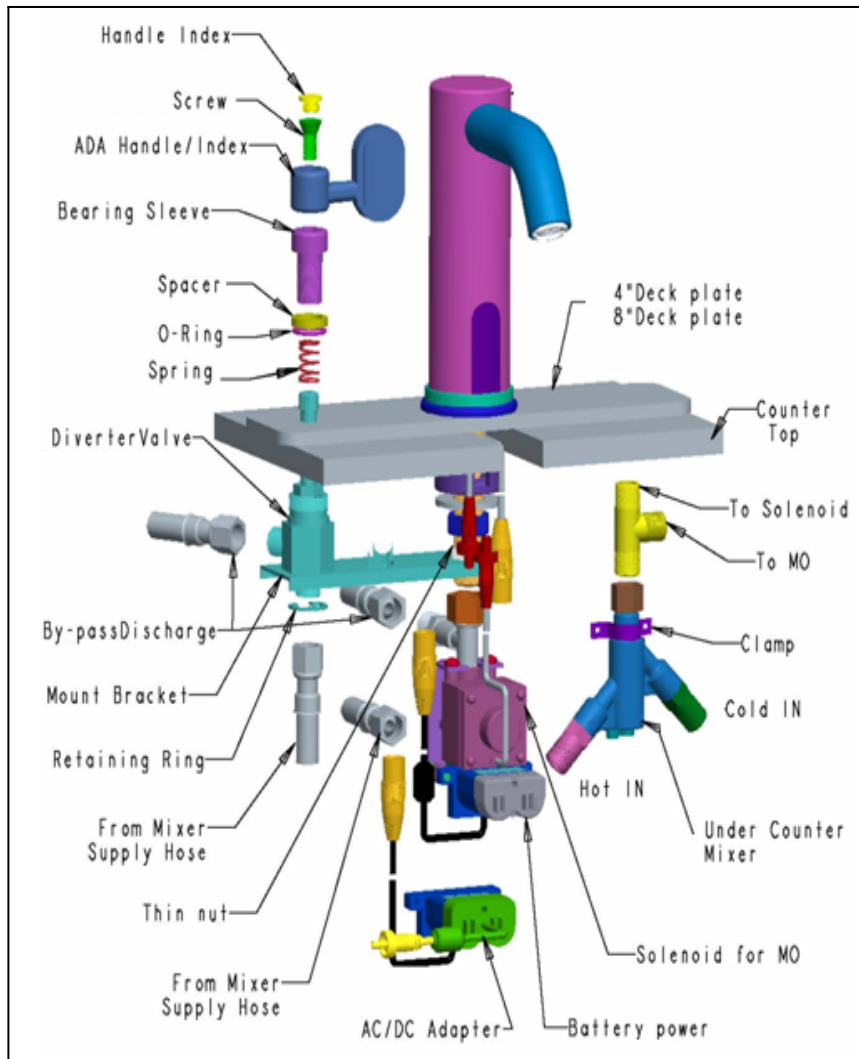

**SPEAKMAN®**

PO Box 191 Wilmington, DE 19899 Phone: 800-537-2107 Fax: 800-977-2747  
Visit us on the web at [www.speakmancompany.com](http://www.speakmancompany.com)

92-2840-R2

### ACM (above counter mixer) with MO (manual override) Installation

1. Install the MO and ACM as described above.

**NOTE:** In this case the ACM has an extra By-pass outlet: -in total 2 branches of mixed water.

2. There are two branches with mixed water: -one goes to Solenoid inlet, and the other goes to bottom of MO.

3. From the side of MO the by-pass hose goes to the upper side of Solenoid discharge for manually controlled side

**NOTE:** For MO is used a Solenoid with a by-pass branch at its outlet.

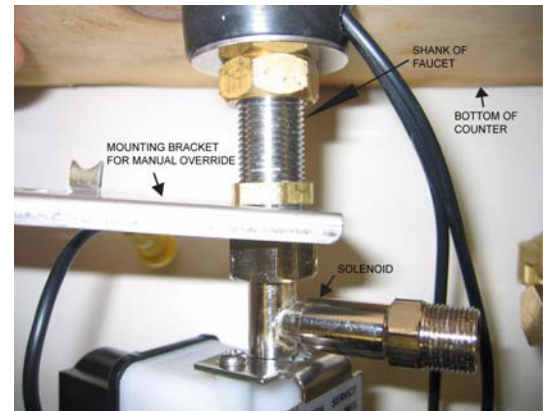
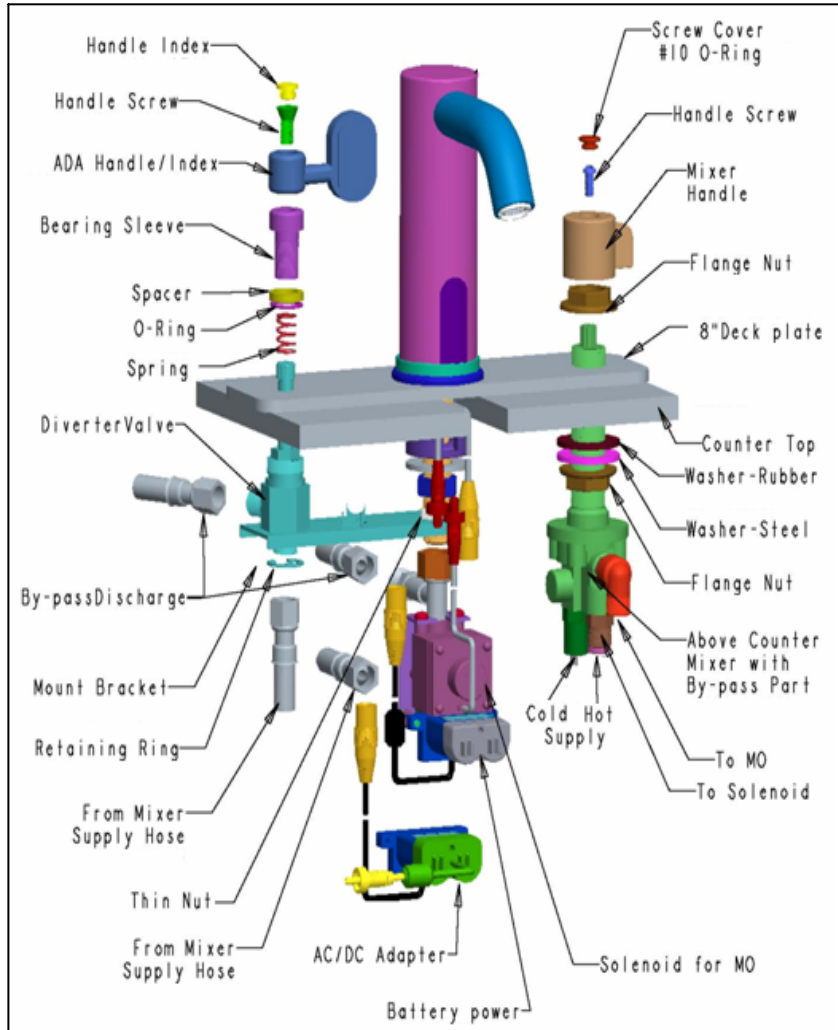

**SPEAKMAN**<sup>®</sup>

PO Box 191 Wilmington, DE 19899 Phone: 800-537-2107 Fax: 800-977-2747  
Visit us on the web at [www.speakmancompany.com](http://www.speakmancompany.com)

92-2840-R2

**MO (Manual Override ) ASSEMBLY INSTALLATION INSTRUCTIONS**  
**FOR SLIM DESIGN FAUCETS**

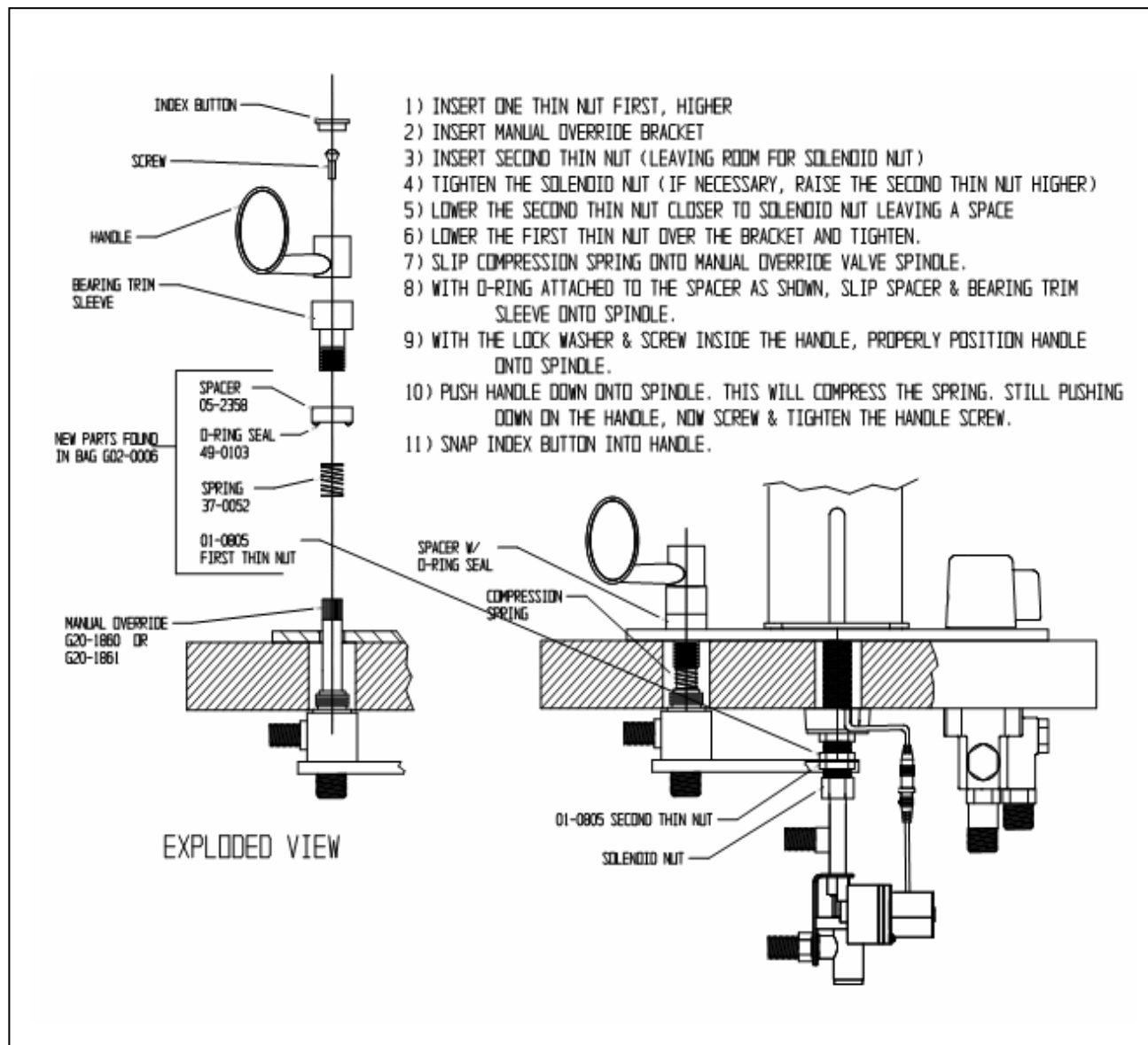

**SPEAKMAN®**

PO Box 191 Wilmington, DE 19899

Phone: 800-537-2107 Fax: 800-977-2747

Visit us on the web at [www.speakmancompany.com](http://www.speakmancompany.com)

92-2840-R2

### MO (Manual Override ) HOSE INSTALLATION INSTRUCTIONS

For ease of installation attach hoses to ACM (above counter mixer) and MO (manual override) diverter before installing under the sink.

1. Attach hot supply hose **1** to inlet ports of mixer (H port) **1** either ACM or UCM.
2. Attach cold supply hose **2** to inlet ports of mixer (C port) **2** either ACM or UCM.
3. Connect one end of diverter supply hose **3** to the Elbow outlet **3** on ACM or TEE outlet **3** on UCM.  
Connect opposite end of hose **3** to the inlet port **3** of the MO Diverter valve.
4. Connect one end of the diverter discharge hose **4** to the outlet port **4** on the MO diverter valve.  
Connect opposite end of hose **4** to by-pass port **4** of the Solenoid valve.
5. Connect one end of Solenoid supply hose **5** to the outlet port **5** on ACM or TEE outlet **5** on UCM.  
Connect opposite end of hose **5** to the inlet port **5** of the Solenoid valve.

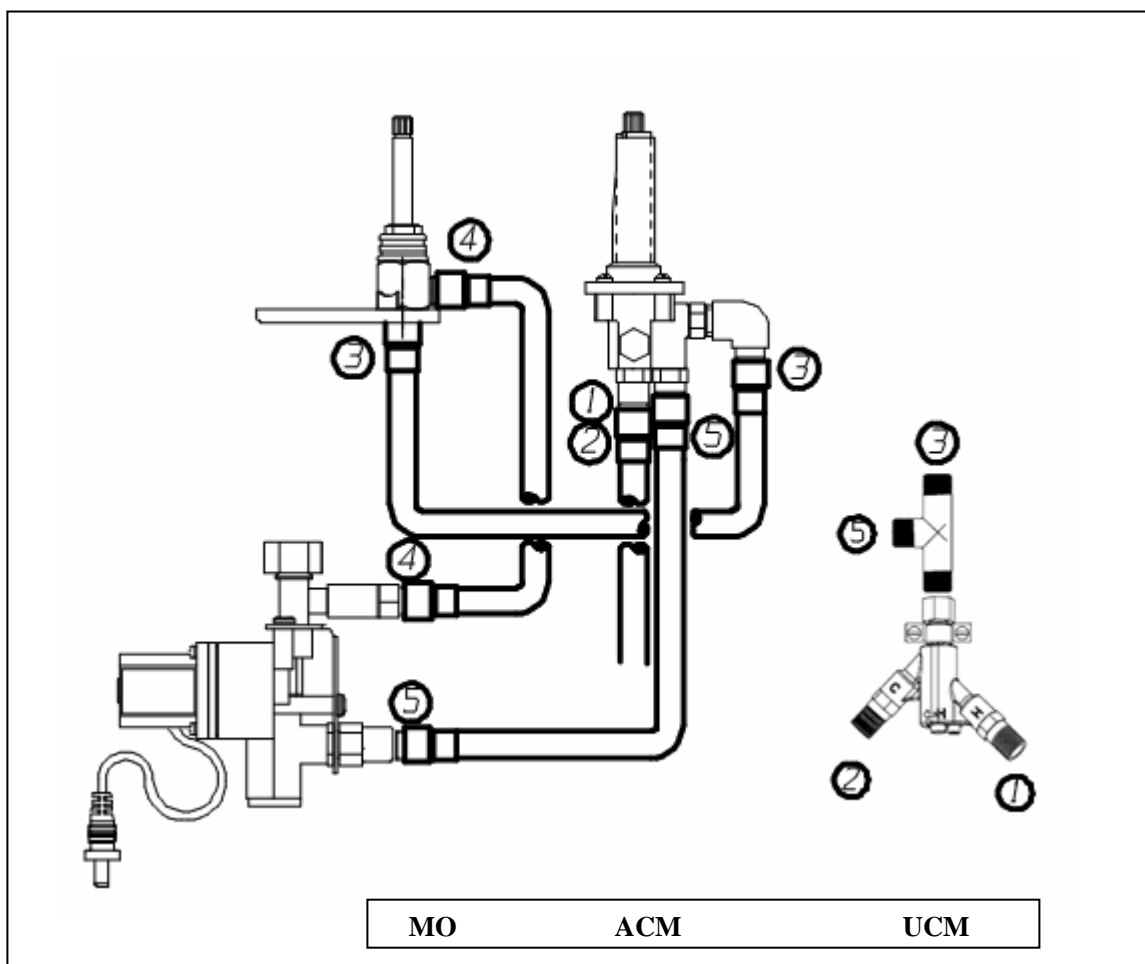

**SPEAKMAN®**

PO Box 191 Wilmington, DE 19899 Phone: 800-537-2107 Fax: 800-977-2747  
Visit us on the web at [www.speakmancompany.com](http://www.speakmancompany.com)

92-2840-R2

**Repair Parts List**

<b>Part/Group Number</b>	<b>Description</b>	<b>Refer to Instructions</b>
RPG05-0674-PC	13/16 -2.2 GPM Aerator repair group	Item
RPG38-0128-PC	13/16 -0.5 GPM Boca repair group	Item
RPG05-0792-PC	Laminar Flow bag group	Item
RPG76-0033-LBL	6V Solenoid Assy	
RPG 76-0039	Solenoid Repair Kit for G76-0033-LBL	Item
RPG 66-0044	Solenoid Filter Screen	Item
RPG66-0168	Infrared Sensor Module (Vertical Style)	Item
RPG66-0169	Battery Power Module	Item
RPG76-0041	3 volt Lithium Batteries (2)	For Battery Module only
RPG66-0169-AC	AC Power Module	Item
RPG66-0010	Transformer AC to 6V DC	Item
RPG20-1845	UCM under counter mixer mounting hardware	Item
RPG66-0111	Handle Assy for ACM replacement	Item
RPG05-0836	Hardware bag group for Slim Design series	Item
66-0163	Flex Hose 3/8 Compression female Stainless Steel 20"lg	Item

**CARE & CLEANING**

- Your SENSORFLO faucet is designed and engineered in accordance with the highest quality and performance standards. With proper care it will provide years of hygienic and trouble free service.
- Periodically the faucet will require some minor maintenance to keep it performing at peak performance. The sensor module has a built-in low battery indicator light. This light will come on when the faucet has approximately 10% of battery life. To replace the batteries follow the installation instructions above.
- Periodically clean the Solenoid Filter.
- The polished chrome finish of your faucet should be cleaned using mild soap and warm water.
- Dry immediately with a soft, clean cloth for best results.
- NEVER use abrasive cleaners, chemicals, alcohol or other solvents. They may damage the surfaces of the non-chrome plated finishes.

**SPEAKMAN®**

PO Box 191 Wilmington, DE 19899 Phone: 800-537-2107 Fax: 800-977-2747  
 Visit us on the web at [www.speakmancompany.com](http://www.speakmancompany.com)

92-2840-R2



## **TROUBLESHOOTING**

Before calling Speakman Company for service, please run through the following checklist of troubleshooting steps. It may be necessary to turn off the hot and cold water supply stops before proceeding to work on the Sensor Faucet.

### **Faucet Operation**

#### **If water flow from the faucet decreases**

1. Make sure the supply stops are open.
2. Ensure both the hot and cold water Temperature Adjusters are not in the closed position (to open, screw out the hot and cold water Temperature Adjusters (counter-clockwise direction)
3. Check that the In-line Filter in the Solenoid body is not blocked with debris. Remove slotted filter screw from the Solenoid Body and rinse filter screen with clean water. Reassemble the filters, open stops, and check water flow. Stops must be off when filters are removed.
4. Remove the outlet device (Aerator) from the spout using the outlet wrench. Operate the faucet with outlet device removed. If water flow is acceptable, disassemble the outlet device and rinse components with clean water.
5. If 1), 2), 3), or 4) do not resolve the problem, call Speakman Company Customer Service for assistance.

#### **If no water flows from the faucet**

##### ***If you can hear clicking sound of solenoid opening, but no water flows***

1. Check to see that the hot and cold water wall stops are completely open.
2. Check that the connectors are correctly connected to the solenoid (Yellow), to Power Module (red) and the transformer (Black)
3. Activation light blinks continuously, even when faucet is not in use. This continuous blinking of the activation light indicates that the batteries inside of the sensor module have low voltages and need to be replaced.
4. Check to see that the In-Line Filter in the Solenoid is not blocked.

##### ***If you do not hear a clicking sound from the solenoid and water does not flow***

Disconnect the existing sensor module and connect a new module directly to the solenoid Power Supply Transformer. Activate the new sensor module and check for water flow. If the water flows, disconnect the new module and reconnect the old module and activate. If the old module still does not work, obtain a replacement module through Speakman Customer Service.

##### ***If Batteries have been replaced but unit still fails to operate***

1. Check battery polarity and electrical connection. Make sure wire plugs are fully inserted into sockets.
2. If faucet does not operate, replace existing sensor module with one you know to be functioning.
3. If faucet operates, contact Speakman Company at 800-537-2107 for a replacement sensor module.
4. If faucet still does not operate, call Speakman Company at 800-537-2107 and ask for the Solenoid Repair Kit, Part No. RPG76-0039, to be shipped to you. Once the kit is received, shut off the hot and cold water supplies to the faucet. Remove sensor module bracket and sensor module. Next, remove the four (4) screws that hold the coil plastic case to the solenoid body and follow the instructions supplied with the kit. After replacing all parts supplied in the kit, reassemble the faucet, open stops, and test the faucet.

##### ***If the faucet activates but will not shut-off***

Contact Speakman Company at 800-537-2107

**SPEAKMAN®**

PO Box 191 Wilmington, DE 19899 Phone: 800-537-2107 Fax: 800-977-2747  
Visit us on the web at [www.speakmancompany.com](http://www.speakmancompany.com)

92-2840-R2

## QUESTIONS & ANSWERS

Q. How does the Sensorflo® faucet work?

A. It uses infrared technology. The sensor emits a non-visible beam of light. When an object enters the detection area, the sensor signals the solenoid valve to open for water to flow. When an object leaves the detection area, the sensor signals the valve to close.

Q. Is the Speakman Sensorflo® faucet sensor beam adjustable?

A. No, the Speakman Sensorflo® faucet sensor beam is not adjustable. It has been factory set to Speakman's specifications for these faucets.

Q. What about water conservation?

A. The Sensorflo® design directly addresses water conservation. Water savings of up to 85% are not unusual. Additional energy savings are realized by conserving hot water.

Q. Can the water temperature of the Sensorflo® faucet be adjusted?

A. Yes, this faucet has hot and cold water mechanical mixing valves. If you need to meet ASSE 1070, you must use our TMV (Therm Mixing Valve) option.

Q. Does Sensorflo® reduce maintenance?

A. By elimination of on/off handles, control components are reduced and fittings stay cleaner longer. Only a light rinsing and wiping is required to restore the beauty of the Sensorflo® faucets. Drip stains are eliminated. Fingerprints and soap spots on sinks and fittings are avoided. Finishes last longer and wash areas stay cleaner. Germs and bacteria are not transferred as easily making for a healthier environment.

Q. The chrome finish on my faucet seems to be deteriorating. What can I do to prevent this from happening?

A. Many commercial cleaning products contain harsh chemicals and abrasives. These products should not be used on any chrome plated plumbing products. Please refer to the Care & Cleaning section of this manual for Speakman Company's recommendations.

Q. Do I require an electrical outlet under the sink for a S-9020 faucet?

A. No, but you will need a source of electricity, 110 VAC. For other optional installations, such as remote or hard wired installations required by state and code regulations, a multi-unit transformer can be located elsewhere and wired to each unit. Contact Speakman Customer Service for Multiple Unit Installations.

Q. Does the Sensorflo® system shut off immediately when an object leaves the sensing area?

A. A very short delay of approximately 0 to 1 second occurs before water is shut off.

Q. Is there a way to adjust the flow of water?

A. Yes, you can choose the option with a 0.5 GPM flow control instead of 2.2 GPM Aerator which comes standard with each faucet. Also the temperature adjusters can also be used to control the flow of water.

Q. Is my faucet protected for power surges?

A. Yes, Sensorflo® has been designed to have built-in power surge protection.

Q. If we lose power, do I have to do something to get the faucet to operate again?

A. After a power outage, the faucet is automatically ready for operation as soon as the power comes back on.

Q. If I call a plumber to come and install this faucet, will they know enough to hook it up?

A. Our installation diagrams are very easy to be followed.

**SPEAKMAN®**

PO Box 191 Wilmington, DE 19899 Phone: 800-537-2107 Fax: 800-977-2747  
Visit us on the web at [www.speakmancompany.com](http://www.speakmancompany.com)

92-2840-R2