

SPEAKMAN COMPANY

S-3014 Installation, Operation & Maintenance Instructions

ANYSTREAM® SHOWERHEAD

DESCRIPTION

Polished chrome plated ANYSTREAM® S-3014 Showerhead with a 3-3/4" outer spray adjustment ring. 5 self-cleaning plunger nozzles resist scale build-up and provide 45 spray streams for a full body coverage pattern. The center core nozzle delivers twelve massaging jets and a combination spray is included. Water conserving pressure compensating AUTOFLO® device reduces flow to 2.5 GPM/9.46LPM maximum, to meet existing ANSI A112.18.1 Standard. 1/2" NPT inlet.

SPECIFICATIONS

SUPPLY INLET: 1/2" NPT
 FLOW RATE: 2.5 GPM/9.46LPM MAXIMUM
 SHIPPING WEIGHT: 1.0 LBS.

OPTIONS

◇ BN – Brushed Nickel
◇ S-3014-E2 – Low Flow Showerhead (2.0 GPM/ 7.6 LPM)
◇ S-3014-BN-E2 – Low Flow Brushed Nickel Showerhead (2.0 GPM/ 7.6 LPM)

INSTALLATION

Remove the old shower head from the shower arm. Clean off any debris on the threads of the shower arm. Wrap Teflon tape around the shower arm threads in a clockwise direction. Turning in a clockwise direction, screw the new Speakman shower head onto the shower arm. Tighten with a wrench. Turn the water supply on and check for leaks.

OPERATION

To adjust the spray pattern of the shower head, simply rotate the outer ring to the desired spray (Full-Body, Dual action or Massage). The outer ring can rotate 360°.

MAINTENANCE

The gleaming finish of your SPEAKMAN ANYSTREAM® shower head can be cleaned by using mild soap and warm water. Dry immediately with a soft, clean cloth for best results. The flow control device limits water flow to 2.5 gallons per minute. The small orifices may become clogged with scale and other minerals found in potable water. To clean the flow regulator, simply remove the shower head from the bent arm, dislodge the flow regulator which is located in the inlet and clean as necessary.

ROUGH-IN MEASUREMENTS

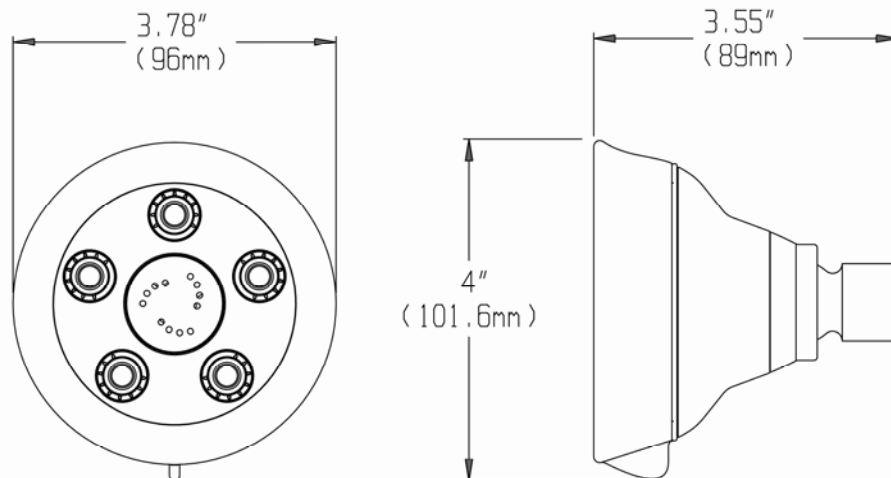

Product improvements may cause specification and dimensional changes without notice.

SPEAKMAN®

PO Box 191 Wilmington, DE 19899 Phone: 800-537-2107 Fax: 800-977-2747
 Visit us on the web at www.speakmancompany.com

1/11
 92-3200
 Rev. 1